

**Anritsu** Advancing beyond

# Spectrum Master™

Ultraportable Spectrum Analyzer

## MS2760A

9 kHz to 32, 44, 50, 70, 90, 110, 145, 170 GHz

## MS2762A

6 GHz to 32, 44, 50, 70, 90, 110, 145, 170 GHz



## Introduction

Utilizing Anritsu's patented nonlinear transmission line (NLTL) technology, the Spectrum Master™ MS2760A and MS2762A ultraportable spectrum analyzer products deliver the best-in-class price/performance ratio unmatched by traditional benchtop instruments. This enables you to more efficiently advance your technology development and reduce your time to market. The Spectrum Master™ MS276xA series are pocket-sized, yet big on performance with leading dynamic range, sweep speed, and amplitude accuracy. The ultraportable size of these instruments enables a direct connection to almost any DUT, eliminating the need for lossy, expensive cables.

The 145 GHz and 170 GHz models are the world's first handheld millimeter-wave spectrum analyzers to provide broadband, continuous coverage from 9 kHz to 170 GHz. These are the world's first and only broadband spectrum analyzers that break through the 110 GHz barrier and enable research and development in the entire D band spectrum. They are perfect for advanced millimeter-wave applications like radio astronomy, automotive radar, antenna beam pattern testing, and more. The Spectrum Master™ MS2760A and MS2762A are USB-powered and controlled from a Windows-based PC, laptop, or tablet, making them uniquely flexible for use in the lab, on the manufacturing floor, or even in the field.

The Spectrum Master™ MS2760A models provide full broadband coverage from 9 kHz to 170 GHz with excellent dynamic range and DANL performance.

The Spectrum Master™ MS2762A models provide even better dynamic range and DANL performance than the Spectrum Master MS2760A models, for the most demanding sensitivity requirements, with frequency coverage starting at 6 GHz and a top frequency range of 170 GHz.

## Spectrum Analyzer Highlights

- Measure: Channel Power, Adjacent Channel Power, Occupied Bandwidth
- Spectrum and Spectrogram Displays
- External 10 MHz Frequency Reference
- External TTL Trigger Input
- Resolution Bandwidth (RBW): 1 Hz to 3 MHz
- Phase Noise:  $-116$  dBc/Hz @ 1 GHz, typical (MS2760A)
- Up to Six Spectrum Traces and Spectrogram Cursors, Three Trace Detectors, 12 Markers
- Dynamic Range:  $> 108$  dB, typical at 70 GHz (MS2762A)
- DANL: as low as  $-142$  dBm (MS2762A, 6 to 40 GHz typical)

## Dimensions

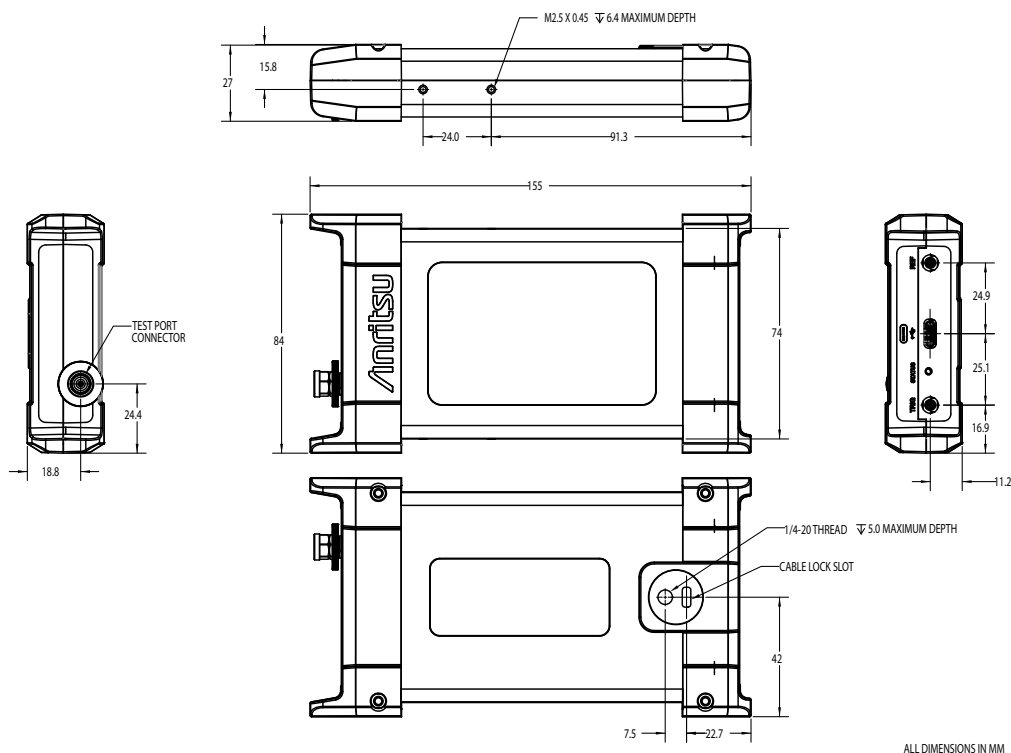

**US Patents** The MS276xA series instruments are protected by the following US patents: 6,894,581; 7,683,633; 8,417,189; 9,287,604

**Table of Contents**

Dimensions.....2  
 Definitions.....3  
 Spectrum Analyzer Measurements.....4  
 MS2760A Spectrum Analyzer.....5  
 MS2762A Spectrum Analyzer.....8  
 General Specifications.....10  
 Ordering Information.....11  
 Standard Accessories.....11  
 Optional Accessories.....12  
 Manuals.....16

**Definitions**

	All specifications and characteristics apply to instruments under the following conditions, unless otherwise stated:
	<ul style="list-style-type: none"> <li>• After 5 minutes of warm-up time, where the instrument is left in the ON state</li> <li>• When using the internal reference signal</li> </ul>
Typical Specifications	Typical specifications are not tested and are not warranted. They are generally representative of characteristic performance. The following models have typical specifications in the following ranges: MS276xA-0044: 40 GHz to 44 GHz typical. MS276xA-0070: 67 GHz to 70 GHz typical. MS276xA-0170: 160 GHz to 170 GHz typical.
Calibration Cycle	Recommended calibration cycle is 12 months.
Time Base Error	Input Frequency × Frequency Reference Error All specifications subject to change without notice. For the most current data sheet, please visit <a href="http://www.anritsu.com">www.anritsu.com</a>



## Spectrum Analyzer Measurements

### Smart Measurements

Channel Power	Measures the total power in a specified bandwidth
Occupied Bandwidth	Measures 99 % to 1 % power channel of a signal
Adjacent Channel Power	Measures channel power of the adjacent channel and alternate channel

### Setup Parameters

Frequency	Center/Start/Stop, Frequency Step, Frequency Offset
Span	Span, Span Up/Down, Full Span, Last Span, Zero Span
Bandwidth	RBW, Auto RBW, VBW, Auto VBW, VBW/RBW, Span/RBW, VBW Log/Lin Averaging
Amplitude	Reference Level, Scale / Division, Units, Ref Level Offset, IF Gain (On/Off), Image Reject (Normal/Low Only/High Only)

### Sweep Functions

Sweep	Single/Continuous, Restart, Sweep Once, Sweep to N, Points, Minimum Capture Time
Zero Span Sweep Time	0.02 ms to 60 s
Sweep (Trace) Points	Settable range from 10 to 10,001 points; the default is 501 points
Minimum Capture Time	0 s to 10 s
Sweep Time Accuracy	± 2% in Zero Span

### Trace Functions

Traces	Up to six traces
Trace Type	Clear / Write, Trace Average, Max Hold, Min Hold, Rolling Average, Rolling Max Hold, Rolling Min Hold
Trace Mode	Active, Hold / View, Blank
Detector Type per Trace	Peak, RMS / Avg, Negative

### Spectrogram

Trace Time Cursor	Up to six Time Cursors to recall historical trace data by trace number or time
Color Setup	Set Color Top/Bottom Range, Set Color Reference Hue

### Marker Functions

Markers	Up to 12 Markers
Marker Mode	Normal, Delta, Fixed
Delta Marker	Relative to any Normal or Fixed Marker
Marker Function	None, Noise
Marker Trace	Assign Marker to any Trace
Peak Search	Peak Search, Next Peak, Next Peak Left, Next Peak Right, Next Point Left, Next Point Right
Peak Search Setup	Peak Threshold, Peak Excursion
Marker →	Mkr → Center, Mkr → Ref Level

### Limit Line Functions

Limit Setup	Upper/Lower, Limit On/Off, Limit Alarm On/Off, Set Default Limit Line, Absolute/Relative
Limit Line Edit	Frequency, Amplitude, Add Point, Add Vertical, Delete Point, Next Point Left/Right
Limit Line Move	To Current Center Frequency, By dB or Hz, To Marker 1, Offset from Marker 1
Limit Line Envelope	Create Envelope, Update Envelope, Points (41 max), Offset, Shape Square/Slope



**MS2760A Spectrum Analyzer**

<b>Frequency</b>	Model Number	Frequency Range (usable to 0 Hz)
	MS2760A-0032	9 kHz to 32 GHz
	MS2760A-0044	9 kHz to 44 GHz
	MS2760A-0050	9 kHz to 50 GHz
	MS2760A-0070	9 kHz to 70 GHz
	MS2760A-0090	9 kHz to 90 GHz
	MS2760A-0110	9 kHz to 110 GHz
	MS2760A-0145	9 kHz to 145 GHz
	MS2760A-0170	9 kHz to 170 GHz
	Tuning Resolution	1 Hz
Internal 10 MHz Frequency Reference	Aging: ±1.0 ppm/year Accuracy: ±0.2 ppm (25 °C ± 25 °C) + aging	
Frequency Span	10 Hz to maximum frequency range of instrument	

<b>Bandwidth</b>		
Resolution Bandwidth (RBW)	1 Hz to 3 MHz (Span ≥10 Hz) Zero Span 5 kHz to 20 MHz	
Video Bandwidth (VBW)	1 Hz to 3 MHz (Span ≥10 Hz) Zero Span 5 kHz to 20 MHz	
VBW/Average Type	Linear / Log	
RBW Filters	Flat Top, Nuttall	
Shape Factor	<5:1 typical	

<b>Amplitude Ranges</b>		
Dynamic Range	> 103 dB typical at 70 GHz, 2/3 (TOI - DANL) in 1 Hz RBW	
Display Range	1 dB to 15 dB/div in 1 dB steps, ten divisions displayed	
Measurement Range	DANL to +10 dBm	
Reference Level Range	-120 dBm to +30 dBm	
Amplitude Units	dBm	
Maximum Safe Level Input	+30 dBm CW, ±10 VDC	

<b>External Trigger</b>		
Source	External, Free Run, Video, Periodic (0 s to 5 s)	
Delay	0 ms to 1670 ms; -60 s (up to sweep time) in zero span and video or external trigger	
Holdoff	0 ms to 5000 ms	
Slope	Rising, Falling, Both	
Hysteresis	0 dB to 200 dB	

**Image Response** The MS2760A employs unique software algorithms to minimize image responses that may appear under certain use cases when wideband modulated and multi-tone signals are being analyzed. Image rejection can be set to use upper or lower mixing products (no image rejection), or both for normal image rejection.

**MS2760A Spectrum Analyzer** (continued)

**Spectral Purity – SSB Phase Noise** (dBc/Hz, 20 °C to 30 °C)

Offset	1 GHz (typical)	6 GHz (maximum)	6 GHz (typical)	30 GHz (maximum)	30 GHz (typical)	60 GHz (maximum)	60 GHz (typical)
1 kHz	-100	-80	-88	-66	-74	-60	-69
10 kHz	-110	-95	-104	-81	-88	-75	-84
100 kHz	-116	-95	-104	-81	-88	-75	-84

**Spurs**

Residual Spurs	maximum (dBm)	typical (dBm)
10 MHz to 70 GHz	-85	-95
> 70 GHz to 90 GHz	-84	-95
> 90 GHz to 110 GHz	-81	-95
> 110 GHz to 145 GHz	-68	-85
> 145 GHz to 170 GHz	-67	-85
Input-related Spurious (-10 dBm CW input)		
@ 28 MHz	-50 dBc (70 MHz input signal)	
@ 35 MHz	-50 dBc (133 MHz input signal)	
@ 770 MHz	-35 dBc (3430 MHz, 4970 MHz, 7630 MHz input signal)	
@ 910 MHz	-35 dBc (4970 MHz, 6790 MHz input signal)	
All other input frequencies	<-60 dBc	
Zero Span	No image rejection is applied to the sweep while in zero span, therefore spurious impact may be different.	

**Amplitude Accuracy**

Frequency	(-10 dBm CW signal) 20 °C to 30 °C (after 30 minute warm-up)		0 °C to 50 °C (after 60 minute warm-up)	
	maximum (dB)	typical (dB)	maximum (dB)	typical (dB)
9 kHz to 644 MHz	±1.3	±0.5	±2.0	±0.5
> 644 MHz to 40 GHz	±1.8	±0.5	±3.0	±1.0
> 40 GHz to 70 GHz	±2.0	±0.5	±3.0	±1.0
> 70 GHz to 90 GHz	±2.2	±0.5	±3.0	±1.0
> 90 GHz to 110 GHz	±2.5	±0.5	±3.0	±1.0
> 110 GHz to 145 GHz	±3.5	±0.5	±4.0	±1.5
> 145 GHz to 170 GHz <sup>a</sup>	±3.5	±0.5	±4.0	±1.5

a. Amplitude Accuracy > 160 GHz typical

**Displayed Average Noise Level (DANL)** (RMS detection, VBW/Avg type = Log, IF Gain On), 1 Hz RBW

Frequency	maximum (dBm)	typical (dBm)
10 MHz to 644 MHz	-131	-134
> 644 MHz to 4 GHz	-136	-140
> 4 GHz to 40 GHz	-131	-134
> 40 GHz to 70 GHz	-128	-132
> 70 GHz to 90 GHz	-127	-130
> 90 GHz to 110 GHz	-123	-127
> 110 GHz to 145 GHz	-112	-120
> 145 GHz to 170 GHz	-111	-115

**Third-Order Intercept (TOI)** (IF Gain Off, typical, 0 dBm tones 1 MHz apart, 0 dBm reference level)

2 GHz	+35 dBm
18 GHz	+35 dBm
62 GHz	+25 dBm

**Second Harmonic Distortion** (at 1 GHz input)

0 dBm Input	-50 dBc maximum
-20 dBm Input	-60 dBc maximum



**MS2760A Spectrum Analyzer** (continued)

**Input Match** (typical)

Frequency	K Connector (2.92 mm) <sup>a</sup>		V Connector (1.85 mm) <sup>b</sup>		W1 Connector (1.0 mm)		0.8 mm Connector	
	VSWR	Return Loss	VSWR	Return Loss	VSWR	Return Loss	VSWR	Return Loss
9 kHz to 12.4 GHz	1.29:1	18 dB	1.29:1	18 dB	1.29:1	18 dB	1.29:1	18 dB
> 12.4 GHz to 26.5 GHz	1.67:1	12 dB	1.43:1	15 dB	1.67:1	12 dB	1.67:1	12 dB
> 26.5 GHz to 40 GHz	1.67:1	12 dB	1.58:1	13 dB	1.67:1	12 dB	1.67:1	12 dB
> 40 GHz to 50 GHz	1.67:1	12 dB	1.67:1	12 dB	1.67:1	12 dB	1.67:1	12 dB
> 50 GHz to 70 GHz	-	-	2.10:1	9 dB	2.10:1	9 dB	2.10:1	9 dB
> 70 GHz to 110 GHz	-	-	-	-	2.10:1	9 dB	2.32:1	8 dB
> 110 GHz to 145 GHz	-	-	-	-	-	-	3.56:1	5 dB
> 145 GHz to 170 GHz	-	-	-	-	-	-	4.42:1	4 dB

a. Compatible with SMA and 3.5 mm connectors.

b. Compatible with 2.4 mm connectors.



## MS2762A Spectrum Analyzer

<b>Frequency</b>	Model Number	Frequency Range
	MS2762A-0032	6 GHz to 32 GHz
	MS2762A-0044	6 GHz to 44 GHz
	MS2762A-0050	6 GHz to 50 GHz
	MS2762A-0070	6 GHz to 70 GHz
	MS2762A-0090	6 GHz to 90 GHz
	MS2762A-0110	6 GHz to 110 GHz
	MS2762A-0145	6 GHz to 145 GHz
	MS2762A-0170	6 GHz to 170 GHz
	Tuning Resolution	1 Hz
Internal 10 MHz Frequency Reference	Aging: $\pm 1.0$ ppm/year Accuracy: $\pm 0.2$ ppm ( $25\text{ }^{\circ}\text{C} \pm 25\text{ }^{\circ}\text{C}$ ) + aging	
Frequency Span	10 Hz to maximum frequency range of instrument	

### Bandwidth

Resolution Bandwidth (RBW)	1 Hz to 3 MHz (Span $\geq 10$ Hz) Zero Span 5 kHz to 20 MHz
Video Bandwidth (VBW)	1 Hz to 3 MHz (Span $\geq 10$ Hz) Zero Span 5 kHz to 20 MHz
VBW/Average Type	Linear / Log
RBW Filters	Flat Top, Nuttall
Shape Factor	<5:1 typical

### Amplitude Ranges

Dynamic Range	> 108 dB typical at 70 GHz, 2/3 (TOI - DANL) in 1 Hz RBW
Display Range	1 dB to 15 dB/div in 1 dB steps, ten divisions displayed
Measurement Range	DANL to 0 dBm
Reference Level Range	-120 dBm to +30 dBm
Amplitude Units	dBm
Maximum Safe Level Input	+18 dBm CW, $\pm 10$ VDC

### External Trigger

Source	External, Free Run, Video, Periodic (0 s to 5 s)
Delay	0 ms to 1670 ms; -60 s (up to sweep time) in zero span and video or external trigger
Holdoff	0 ms to 5000 ms
Slope	Rising, Falling, Both
Hysteresis	0 dB to 200 dB

**Image Response** The MS2762A employs unique software algorithms to minimize image responses that may appear under certain use cases when wideband modulated and multi-tone signals are being analyzed. Image rejection can be set to use upper or lower mixing products (no image rejection), or both for normal image rejection.





**MS2762A Spectrum Analyzer** (continued)

**Spectral Purity – SSB Phase Noise**

Offset	(dBc/Hz, 20 °C to 30 °C)						
	7 GHz (maximum)	7 GHz (typical)	30 GHz (maximum)	30 GHz (typical)	60 GHz (maximum)	60 GHz (typical)	
1 kHz	-80	-89	-66	-74	-60	-69	
10 kHz	-93	-97	-81	-88	-75	-84	
100 kHz	-94	-98	-81	-88	-75	-84	

**Spurs**

Residual Spurs	maximum (dBm)	typical (dBm)
6 GHz to 70 GHz	-85	-95
> 70 GHz to 90 GHz	-84	-95
> 90 GHz to 110 GHz	-81	-95
> 110 GHz to 145 GHz	-68	-85
> 145 GHz to 170 GHz	-67	-85
Input-related Spurious	<-60 dBc (-20 dBm CW input)	
Zero Span	No image rejection is applied to the sweep while in zero span, therefore spurious impact may be different.	

**Amplitude Accuracy**

Frequency	(-10 dBm CW signal) 20 °C to 30 °C (after 30 minute warm-up)		0 °C to 50 °C (after 60 minute warm-up)	
	maximum (dB)	typical (dB)	maximum (dB)	typical (dB)
≥ 6 GHz to 40 GHz	±1.8	±0.5	±3.0	±1.0
> 40 GHz to 70 GHz	±2.0	±0.5	±3.0	±1.0
> 70 GHz to 90 GHz	±2.2	±0.5	±3.0	±1.0
> 90 GHz to 110 GHz	±2.5	±0.5	±3.0	±1.0
> 110 GHz to 145 GHz	±3.5	±0.5	±4.0	±1.5
> 145 GHz to 170 GHz <sup>a</sup>	±3.5	±0.5	±4.0	±1.5

a. Amplitude Accuracy > 160 GHz typical

**Displayed Average Noise Level (DANL)** (RMS detection, VBW/Avg type = Log, IF Gain On, 1 Hz RBW)

Frequency	maximum (dBm)	typical (dBm)
> 6 GHz to 40 GHz	-135	-142
> 40 GHz to 70 GHz	-137	-141
> 70 GHz to 90 GHz	-136	-141
> 90 GHz to 110 GHz	-132	-136
> 110 GHz to 145 GHz	-119	-129
> 145 GHz to 170 GHz	-114	-122

**Third-Order Intercept (TOI)** (IF Gain Off, typical, -10 dBm tones 1 MHz apart, -10 dBm reference level)

18 GHz	+22 dBm
62 GHz	+21 dBm

**Second Harmonic Distortion** (at 7 GHz input)

-25 dBm Input	-50 dBc maximum
---------------	-----------------

**Input Match** (typical)

Frequency	K Connector (2.92 mm) <sup>a</sup>		V Connector (1.85 mm) <sup>b</sup>		W1 Connector (1.0 mm)		0.8 mm Connector	
	VSWR	Return Loss	VSWR	Return Loss	VSWR	Return Loss	VSWR	Return Loss
6 GHz to 12.4 GHz	1.92:1	10 dB	1.92:1	10 dB	1.92:1	10 dB	1.92:1	10 dB
> 12.4 GHz to 50 GHz	1.78:1	11 dB	1.78:1	11 dB	1.78:1	11 dB	1.78:1	11 dB
> 50 GHz to 70 GHz	-	-	2.32:1	8 dB	2.32:1	8 dB	2.32:1	8 dB
> 70 GHz to 110 GHz	-	-	-	-	3.01:1	9 dB	3.01:1	6 dB
> 110 GHz to 145 GHz	-	-	-	-	-	-	4.42:1	4 dB
> 145 GHz to 170 GHz	-	-	-	-	-	-	4.42:1	4 dB

a. Compatible with SMA and 3.5 mm connectors.

b. Compatible with 2.4 mm connectors.

## General Specifications

### Setup Parameters

System Information	Connected To, Manufacturer, Model Number, Serial Number, Server Version, Client Version, Frequency
Settings Display	Color Theme (Default/Light)
Settings Screenshot	Capture Region (Entire Application/Graphs Only), Color (Standard/Printable), Annotations (Footer/Header), Directory, File Naming (Automatic Timestamp/Manual)
File	Quick Save, Save As, Recall, Save On Event, Browse Files
Save On Event	Limit Crossed (Off/Single/Continuous), Sweep End (Off/Single/Continuous), Interval, Clear All Events

### Connectors

RF In	32 GHz and 44 GHz Instruments: K Connector (2.92 mm), male 50 $\Omega$ 50 GHz and 70 GHz Instruments: V Connector (1.85 mm), male 50 $\Omega$ 90 GHz and 110 GHz Instruments: W Connector (1.0 mm), male 50 $\Omega$ 145 GHz and 170 GHz Instruments: 0.8 mm Connector, (0.8mm), male 50 $\Omega$
USB Interface	USB 3.0, Type C Connector
External Reference In	MCX(f), 50 $\Omega$ , 10 MHz
External Trigger In	MCX(f), 50 $\Omega$ , TTL Levels

### Computer Requirement

Display Resolution	16:9 / 16:10 Aspect Ratio (>1280 x 720 / 1280 x 800)
Operating System	Windows® 7, 8.1, 10; 64-bit
Recommended Minimum Configuration	Quad Core i7 fourth generation or higher CPU, 16 GB RAM, 128 GB Data Storage, USB 3.0

### Regulatory Compliance

	(not including Windows Tablet/Laptop/PC)
European Union	EMC 2014/30/EU, EN 61326:2013, CISPR 11/EN 55011, IEC/EN 61000-4-2/3/4/5/6/8/11 Low Voltage Directive 2014/35/EU Safety EN 61010-1:2010 RoHS Directive 2011/65/EU applies to instruments with CE marking placed on the market after July 22, 2017
Australia and New Zealand	RCM AS/NZS 4417:2012
South Korea	KCC-REM-A21-0004

### Environmental

	MIL-PRF-28800F Class 3 (not including Windows Tablet/Laptop/PC)
Operating Temperature Range	0 °C to 50 °C
Storage Temperature Range	-40 °C to 71 °C
Maximum Relative Humidity	95 % RH at 30 °C, non-condensing
Vibration, Sinusoidal	5 Hz to 55 Hz
Vibration, Random	10 Hz to 500 Hz
Half Sine Shock	30 g <sub>n</sub>
Altitude	4600 meters, operating and non-operating
Explosive Atmosphere	MIL-PRF-28800F Section 4.5.6.3 MIL-STD-810G, Method 511.5, Procedure 1

### Warranty

Duration	Standard three-year warranty
----------	------------------------------

### Size and Weight (not including Windows Tablet/Laptop/PC)

Size	155 mm x 84 mm x 27 mm (6.1 in x 3.3 in x 1.1 in)
Weight	255 g (9.0 oz)

Ordering Information

Models and Options



Model Number	Description
MS2760A-0032	Spectrum Master, Ultraportable Spectrum Analyzer, 9 kHz to 32 GHz
MS2760A-0044	Spectrum Master, Ultraportable Spectrum Analyzer, 9 kHz to 44 GHz
MS2760A-0050	Spectrum Master, Ultraportable Spectrum Analyzer, 9 kHz to 50 GHz
MS2760A-0070	Spectrum Master, Ultraportable Spectrum Analyzer, 9 kHz to 70 GHz
MS2760A-0090	Spectrum Master, Ultraportable Spectrum Analyzer, 9 kHz to 90 GHz
MS2760A-0110	Spectrum Master, Ultraportable Spectrum Analyzer, 9 kHz to 110 GHz
MS2760A-0145	Spectrum Master, Ultraportable Spectrum Analyzer, 9 kHz to 145 GHz
MS2760A-0170	Spectrum Master, Ultraportable Spectrum Analyzer, 9 kHz to 170 GHz
MS2762A-0032	Spectrum Master, Ultraportable Spectrum Analyzer, 6 GHz to 32 GHz
MS2762A-0044	Spectrum Master, Ultraportable Spectrum Analyzer, 6 GHz to 44 GHz
MS2762A-0050	Spectrum Master, Ultraportable Spectrum Analyzer, 6 GHz to 50 GHz
MS2762A-0070	Spectrum Master, Ultraportable Spectrum Analyzer, 6 GHz to 70 GHz
MS2762A-0090	Spectrum Master, Ultraportable Spectrum Analyzer, 6 GHz to 90 GHz
MS2762A-0110	Spectrum Master, Ultraportable Spectrum Analyzer, 6 GHz to 110 GHz
MS2762A-0145	Spectrum Master, Ultraportable Spectrum Analyzer, 6 GHz to 145 GHz
MS2762A-0170	Spectrum Master, Ultraportable Spectrum Analyzer, 6 GHz to 170 GHz

Option Number	Description
MS276xA-0032-0098	
MS276xA-0044-0098	
MS276xA-0050-0098	
MS276xA-0070-0098	
MS276xA-0090-0098	Standard Calibration (ISO/IEC 17025 and ANSI/NCSL Z540-1)
MS276xA-0110-0098	
MS276xA-0145-0098	
MS276xA-0170-0098	
MS276xA-0032-0099	
MS276xA-0044-0099	
MS276xA-0050-0099	
MS276xA-0070-0099	
MS276xA-0090-0099	Premium Calibration (ISO/IEC 17025 and ANSI/NCSL Z540-1 plus test data)
MS276xA-0110-0099	
MS276xA-0145-0099	
MS276xA-0170-0099	
MS2762A-0032-0098	
MS2762A-0044-0098	
MS2762A-0050-0098	
MS2762A-0070-0098	
MS2762A-0090-0098	Standard Calibration (ISO/IEC 17025 and ANSI/NCSL Z540-1)
MS2762A-0110-0098	
MS2762A-0145-0098	
MS2762A-0170-0098	
MS2762A-0032-0099	
MS2762A-0044-0099	
MS2762A-0050-0099	
MS276xA-0070-0099	
MS2762A-0090-0099	Premium Calibration (ISO/IEC 17025 and ANSI/NCSL Z540-1 plus test data)
MS2762A-0110-0099	
MS2762A-0145-0099	
MS2762A-0170-0099	

Standard Accessories (included with instrument)

Accessory	Description
	2000-1859-R USB 3.0 Type C to Type A Cable, 1 m
Certificate of Calibration and Conformance	

Accessory	Description
	2000-1605-R BNC(m) to MCX(m) Cable (qty 2)

## Optional Accessories



Coaxial Adapters			
Accessory	Description	Accessory	Description
	34VFK50A DC to 43.5 GHz, V(f) to K(m), 50 Ω		33W.850 Calibration Grade Adapter, W1(m) to 0.8 mm (m), DC to 110 GHz, 50 Ω
	34VFKF50A DC to 43.5 GHz, V(f) to K(f), 50 Ω		33W.8F50 Calibration Grade Adapter, W1(m) to 0.8 mm (f), DC to 110 GHz, 50 Ω
	34VV50 DC to 65 GHz, V(m) to V(m), 50 Ω		33WF.850 Calibration Grade Adapter, W1(f) to 0.8 mm (m), DC to 110 GHz, 50 Ω
	34VVF50 DC to 65 GHz, V(f) to V(m), 50 Ω		33WF.8F50 Calibration Grade Adapter, W1(f) to 0.8 mm (f), DC to 110 GHz, 50 Ω
	34VVFV50 DC to 65 GHz, V(f) to V(f), 50 Ω		33.8.850 Calibration Grade Adapter, 0.8 mm (m) to 0.8 mm (m), DC to 145 GHz, 50 Ω
	34WV50 Precision Adapter, DC to 65 GHz, W1(m) to V(m), 50 Ω		33.8.8F50 Calibration Grade Adapter, 0.8 mm (m) to 0.8 mm (f), DC to 145 GHz, 50 Ω
	34WVF50 Precision Adapter, DC to 65 GHz, W1(m) to V(f), 50 Ω		33.8F.8F50 Calibration Grade Adapter, 0.8 mm (f) to 0.8 mm (f), DC to 145 GHz, 50 Ω
	34WVFV50 Precision Adapter, DC to 65 GHz, W1(f) to V(m), 50 Ω		2000-1880-R DC to 18 GHz, N(m) to V(f), 50 Ω
	34WVVF50 Precision Adapter, DC to 65 GHz, W1(f) to V(f), 50 Ω		2000-1881-R DC to 18 GHz, N(f) to V(f), 50 Ω
	33WW50 W1(m) to W1(m)		K222B DC to 40 GHz, K(f) to K(f), 50 Ω
	33WVVF50 W1(m) to W1(f)		33WVVF50 W1(f) to W1(f)

Accessory	Description
	43KC-3 Precision, DC to 26.5 GHz, 1W, 3 dB, K(m) to K(f)
	43KC-6 Precision, DC to 26.5 GHz, 1W, 6 dB, K(m) to K(f)
	43KC-10 Precision, DC to 26.5 GHz, 1W, 10 dB, K(m) to K(f)
	43KC-20 Precision, DC to 26.5 GHz, 1W, 20 dB, K(m) to K(f)
	41KB-3 Precision, DC to 26.5 GHz, 1W, 3 dB, K(m) to K(f)
	41KB-6 Precision, DC to 26.5 GHz, 1W, 6 dB, K(m) to K(f)
	41KB-10 Precision, DC to 26.5 GHz, 1W, 10 dB, K(m) to K(f)
	41KB-20 Precision, DC to 26.5 GHz, 1W, 20 dB, K(m) to K(f)
	41KC-3 Precision, DC to 40 GHz, 1W, 3 dB, K(m) to K(f)
	41KC-6 Precision, DC to 40 GHz, 1W, 6 dB, K(m) to K(f)
	41KC-10 Precision, DC to 40 GHz, 1W, 10 dB, K(m) to K(f)
	41KC-20 Precision, DC to 40 GHz, 1W, 20 dB, K(m) to K(f)

Accessory	Description
	41VA-3 Precision, DC to 70 GHz, 1W, 3 dB, V(m) to V(f)
	41VA-6 Precision, DC to 70 GHz, 1W, 6 dB, V(m) to V(f)
	41VA-10 Precision, DC to 70 GHz, 1W, 10 dB, V(m) to V(f)
	41VA-20 Precision, DC to 70 GHz, 1W, 20 dB, V(m) to V(f)
	41VA-30 Precision, DC to 70 GHz, 1W, 30 dB, V(m) to V(f)
	41VA-40 Precision, DC to 70 GHz, 1W, 40 dB, V(m) to V(f)
	41W-3 DC to 110 GHz, 0.2 W, 3 dB, W1(m) to W1(f), 50 Ω
	41W-6 DC to 110 GHz, 0.2 W, 6 dB, W1(m) to W1(f), 50 Ω
	41W-10 DC to 110 GHz, 0.2 W, 10 dB, W1(m) to W1(f), 50 Ω

Miscellaneous Components

Accessory	Description
	W240A Precision Power Divider, DC to 110 GHz, W1(f) input, W1(f) outputs, 3 resistor, 50 Ω
	W241A Precision Power Splitter, DC to 110 GHz, W1(m) input, W1(f) outputs, 2 resistor, 50 Ω
	MN25110A Precision Directional Coupler, 20 GHz to 110 GHz, W1(f) input, W1(f) output, W1(f) coupled port, 50 Ω
	2000-1929-R Low Noise Amplifier, 18 GHz to 42 GHz, 28 dB Gain, V(m) to V(f)
	2000-1930-R Low Noise Amplifier, 18 GHz to 42 GHz, 28 dB Gain, K(m) to K(f)

Accessory	Description
	01-201 Torque Wrench, 0.9 N*m (8 lbf*in) for K, V, SMA, 3.5 mm, 2.4 mm connectors
	01-504 Torque Wrench, 0.45 N*m (4 lbf*in) for W1, 1.0 mm connectors
	01-524 Torque Wrench, 0.45 N*m (4 lbf*in) for 0.8 mm connectors

**Precision Waveguide Coaxial Adapters (right angle)**

Accessory	Description
	35WR42KF 18 GHz to 26.5 GHz, WR42 to K(f)
	35WR28KF 26.5 GHz to 40 GHz, WR28 to K(f)
	35WR22VF 33 GHz to 50 GHz, WR22 to V(f)
	35WR19VF 40 GHz to 60 GHz, WR19 to V(f)

Accessory	Description
	35WR15VF 50 GHz to 65 GHz, WR15 to V(f)
	35WR10WF 75 GHz to 110 GHz, WR10 to W1(f)
	SC7442 60 GHz to 90 GHz, WR12 to W1(f)

**Waveguide to Coaxial End Launch Adapters (straight through)**

Accessory	Description
	2000-1889-R 17.6 GHz to 26.7 GHz, WR42 to K(f)
	2000-1890-R 26.4 GHz to 40.1 GHz, WR28 to K(f)
	1091-460-R 17.6 GHz to 26.7 GHz, WR42 to V(f)
	1091-459-R 26.4 GHz to 40.1 GHz, WR28 to V(f)
	1091-458-R 33.0 GHz to 50.1 GHz, WR22 to V(f)



Accessory	Description
	1091-457-R 39.3 GHz to 59.7 GHz, WR19 to V(f)
	1091-456-R 49.9 GHz to 67.0 GHz, WR15 to V(f)
	1091-402-R 49.9 GHz to 75.8 GHz, WR15 to W1(f)
	1091-401-R 60.5 GHz to 92.0 GHz, WR12 to W1(f)
	1091-400-R 73.8 GHz to 110 GHz, WR10 to W1(f)



**Directional Horn Antennas**

Accessory	Description
	2000-1867-R 17.6 GHz to 26.7 GHz, WR42, 25 dBi gain
	2000-1868-R 26.4 GHz to 40.1 GHz, WR28, 25 dBi gain
	2000-1869-R 33.0 GHz to 50.1 GHz, WR22, 25 dB gain
	2000-1870-R 39.3 GHz to 59.7 GHz, WR19, 25 dBi gain

Accessory	Description
	2000-2003-R 24 GHz to 40 GHz, WR28, 19 dBi gain (small form factor assembly with K(f) adapter, mounting bracket, and case)

**Test Port Cables (Armored, Semi-rigid)**

Accessory	Description
	3670K50A-1 K(f) to K(m), 30.48 cm
	3670K50A-2 K(f) to K(m), 60.96 cm
	3670V50A-1 DC to 70 GHz, V(f) to V(m), 30.5 cm (1 ft)
	3670V50A-2 DC to 70 GHz, V(f) to V(m), 61.0 cm (2 ft)
	3670W50-1 DC to 110 GHz, W1(m) to W1(f), 10 cm
	3670W50-2 DC to 110 GHz, W1(m) to W1(f), 16 cm

Accessory	Description
	3671W1-50-1 DC to 110 GHz, Flexible, W1(f) to W1(m), 10 cm
	3671W1-50-2 DC to 110 GHz, Flexible, W1(f) to W1(m), 13 cm
	3671W1-50-3 DC to 110 GHz, Flexible, W1(f) to W1(m), 16 cm
	3670.850-1 Test Port Cable, Armored, Semi-rigid, 0.8 mm(m) to 0.8 mm(f) 10 cm
	3670.850-2 Test Port Cable, Armored, Semi-rigid, 0.8 mm(m) to 0.8 mm(f) 16 cm
	3671W1-50-3 DC to 110 GHz, Flexible, W1(f) to W1(m), 16 cm

**USB Cable Extender**

Accessory	Description
	2000-1888-R USB 3.0 Powered Extension Cable, 10 m, (32 ft) (up to two can be used in series for a total length of 20 m)

Accessory	Description
	2000-1917-R 4-port 100 m USB CAT 6A/7 Extender System
	2000-1918-R 4-port 200 m USB Multimode Fiber Extender System

**Manuals** (available at [www.anritsu.com](http://www.anritsu.com))

Part Number	Description
10580-00427	User Guide



Notes

## Training at Anritsu

Anritsu has designed courses to help you stay up-to-date with technologies important to your job. For available training courses, visit: [www.anritsu.com/training](http://www.anritsu.com/training)



### • United States

**Anritsu Americas Sales Company**  
450 Century Parkway, Suite 190,  
Allen, TX 75013, U.S.A.  
Phone: +1-800-Anritsu (1-800-267-4878)

### • Canada

**Anritsu Electronics Ltd.**  
700 Silver Seven Road, Suite 120,  
Kanata, Ontario K2V 1C3, Canada  
Phone: +1-613-591-2003  
Fax: +1-613-591-1006

### • Brazil

**Anritsu Eletronica Ltda.**  
Praça Amadeu Amaral, 27 - 1 Andar  
01327-010 - Bela Vista - Sao Paulo - SP, Brazil  
Phone: +55-11-3283-2511  
Fax: +55-11-3288-6940

### • Mexico

**Anritsu Company, S.A. de C.V.**  
Blvd Miguel de Cervantes Saavedra #169 Piso 1,  
Col. Granada, Mexico, Ciudad de Mexico,  
11520, MEXICO  
Phone: +52-55-4169-7104

### • United Kingdom

**Anritsu EMEA Ltd.**  
200 Capability Green,  
Luton, Bedfordshire, LU1 3LU, U.K.  
Phone: +44-1582-433200  
Fax: +44-1582-731303

### • France

**Anritsu S.A.**  
12 avenue du Québec, Immeuble Goyave,  
91140 VILLEBON SUR YVETTE, France  
Phone: +33-1-60-92-15-50

### • Germany

**Anritsu GmbH**  
Nemetschek Haus, Konrad-Zuse-Platz 1,  
81829 München, Germany  
Phone: +49-89-442308-0  
Fax: +49-89-442308-55

### • Italy

**Anritsu S.r.l.**  
Spaces Eur Arte, Viale dell'Arte 25, 00144 Roma, Italy  
Phone: +39-6-509-9711

### • Sweden

**Anritsu AB**  
Kistagången 20 B, 2 tr, 164 40 Kista, Sweden  
Phone: +46-8-534-707-00

### • Finland

**Anritsu AB**  
Technopolis Aviapolis, Teknobulevardi 3-5 (D208.5),  
FI-01530 Vantaa, Finland  
Phone: +358-20-741-8100

### • Denmark

**Anritsu A/S**  
c/o Regus Winghouse, Ørestads Boulevard 73, 4th  
floor,  
2300 Copenhagen S, Denmark  
Phone: +45-7211-2200

### • Russia

**Anritsu EMEA Ltd.**  
**Representation Office in Russia**  
Tverskaya str. 16/2, bld. 1, 7th floor,  
Moscow 125009, Russia  
Phone: +7-495-363-1694  
Fax: +7-495-935-8962

### • Spain

**Anritsu EMEA Ltd.**  
**Representation Office in Spain**  
Paseo de la Castellana, 141.  
Planta 5, Edificio Cuzco IV  
28046, Madrid, Spain  
Phone: +34-91-572-6761

### • Austria

**Anritsu EMEA GmbH**  
Am Belvedere 10, A-1100 Vienna, Austria  
Phone: +43-(0)1-717-28-710

### • United Arab Emirates

**Anritsu EMEA Ltd.**  
**Anritsu A/S**  
Office No. 164, Building 17, Dubai Internet City  
P. O. Box - 501901, Dubai, United Arab Emirates  
Phone: +971-4-3758479

### • India

**Anritsu India Private Limited**  
6th Floor, Indiqube ETA, No.38/4, Adjacent to EMC2,  
Doddanekundi, Outer Ring Road,  
Bengaluru - 560048, India  
Phone: +91-80-6728-1300  
Fax: +91-80-6728-1301

### • Singapore

**Anritsu Pte. Ltd.**  
11 Chang Charn Road, #04-01, Shriro House  
Singapore 159640  
Phone: +65-6282-2400  
Fax: +65-6282-2533

### • Vietnam

**Anritsu Company Limited**  
16th Floor, Peakview Tower, 36 Hoang Cau Street,  
O Cho Dua Ward, Dong Da District, Hanoi, Vietnam  
Phone: +84-24-3201-2730

### • P.R. China (Shanghai)

**Anritsu (China) Co., Ltd.**  
Room 2701-2705, Tower A, New Caohejing  
International Business Center No. 391 Gui Ping Road  
Shanghai, 200233, P.R. China  
Phone: +86-21-6237-0898  
Fax: +86-21-6237-0899

### • P.R. China (Hong Kong)

**Anritsu Company Ltd.**  
Unit 1006-7, 10/F., Greenfield Tower, Concordia Plaza,  
No. 1 Science Museum Road, Tsim Sha Tsui East,  
Kowloon, Hong Kong, P.R. China  
Phone: +852-2301-4980  
Fax: +852-2301-3545

### • Japan

**Anritsu Corporation**  
8-5, Tamura-cho, Atsugi-shi, Kanagawa, 243-0016  
Japan  
Phone: +81-46-296-6509  
Fax: +81-46-225-8352

### • South Korea

**Anritsu Corporation, Ltd.**  
5FL, 235 Pangyoyeok-ro, Bundang-gu, Seongnam-si,  
Gyeonggi-do 13494, South Korea  
Phone: +82-31-696-7750  
Fax: +82-31-696-7751

### • Australia

**Anritsu Pty. Ltd.**  
Unit 20, 21-35 Ricketts Road,  
Mount Waverley, Victoria 3149, Australia  
Phone: +61-3-9558-8177  
Fax: +61-3-9558-8255

### • Taiwan

**Anritsu Company Inc.**  
7F, No. 316, Sec. 1, NeiHu Rd., Taipei 114, Taiwan  
Phone: +886-2-8751-1816  
Fax: +886-2-8751-1817

List Revision Date: 20210610