



Double Ridged Horn Antenna

The DRH110 antenna is a gem that is small in size but excels in electric ones. With a frequency exceeding 110 GHz, the DRH110 deserves a special gold finish.

Features and Specifications



Technical Performance

- Wide bandwidth
- Low return loss
- Individual calibration
- Covers 5G frequency band



Design and Surface Treatment

- Gold plated coating
- Includes standard mount
- Storage in protective tailor-made wooden box



Manufacturing Technology

- Manufactured using a high grade aluminum alloy
- Extremely durable
- High quality 1.0mm type coaxial connector



Product Packaging Includes

- Adapter with 1/4 inch inner thread, supplied with antenna

Product Parameters

PRODUCT IDENTIFICATION

Product Name	DRH110
Product Category	Double Ridged Horn Antenna

ELECTRICAL SPECIFICATIONS

Frequency Range	14 GHz – 110 GHz
VSWR (max.)	2.1
VSWR (avg.)	1.4
Impedance	50 Ohm
Connector	1.0mm (female)
Power (CW / Peak)	4 W / 8 W
Antenna Factor	44.3 – 53.7 dB/m
Polarization	Linear

PHYSICAL SPECIFICATIONS

Width	18.6 mm (0.732 in)
Height	31.9 mm (1.256 in)
Depth	15.7 mm (0.618 in)
Weight	0.022 kg (0.049 lb)

OPERATING CONDITIONS

Rated Temperature Range	0°C – +50°C
Storage Temperature Range	-20°C – +70°C

MOUNTING FLANGE

Mounting	Adapter with 1/4 inch inner thread, supplied with antenna
----------	--

Mechanical Drawings

Antenna

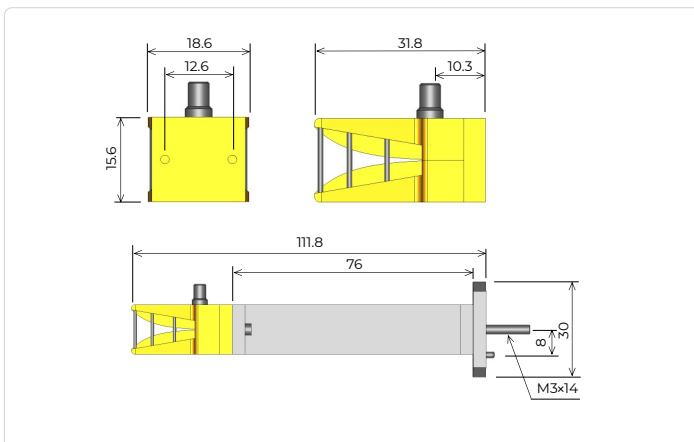

Mounting flange

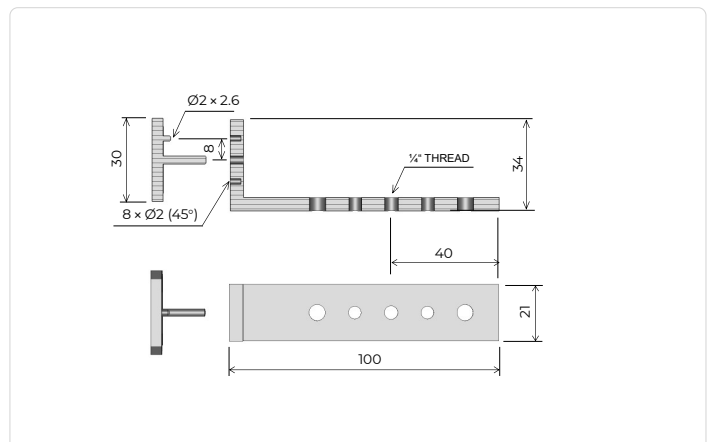

Parameters and Performance

Typical parameters

VSWR

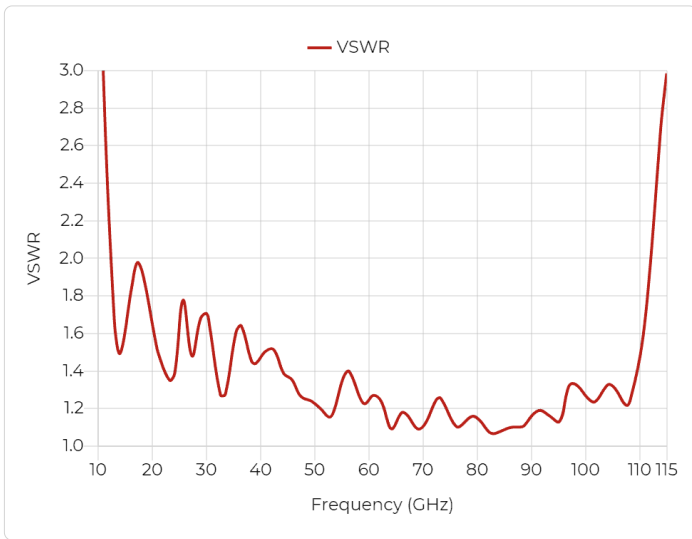

Gain

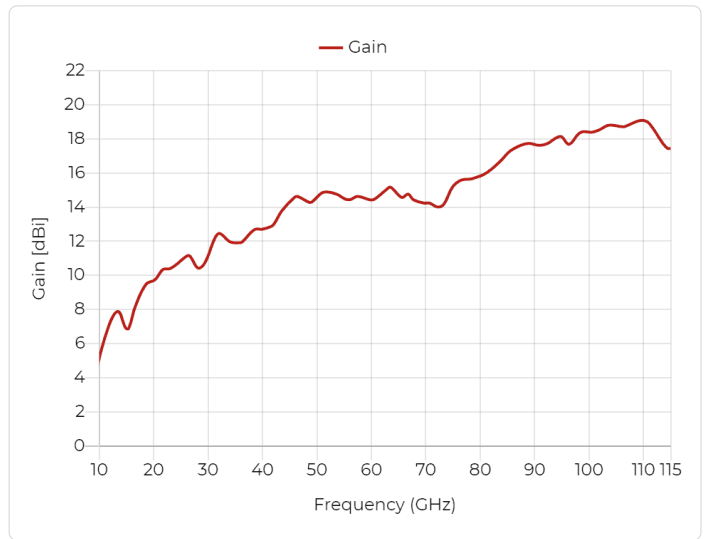

Antenna Factor

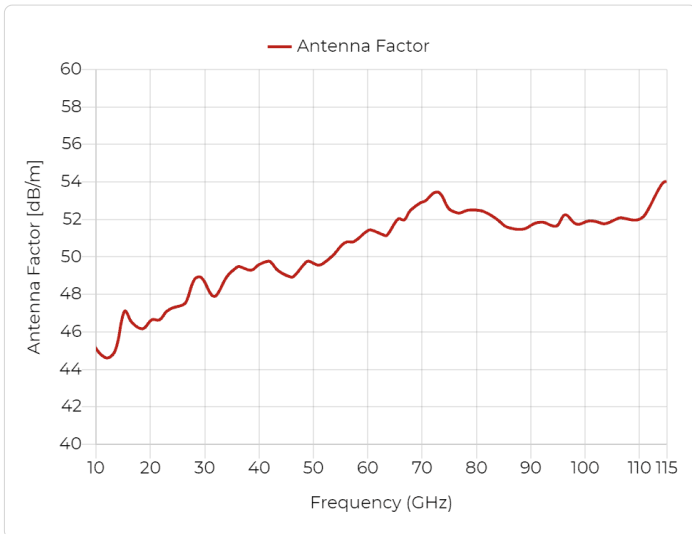

Cross Polarization

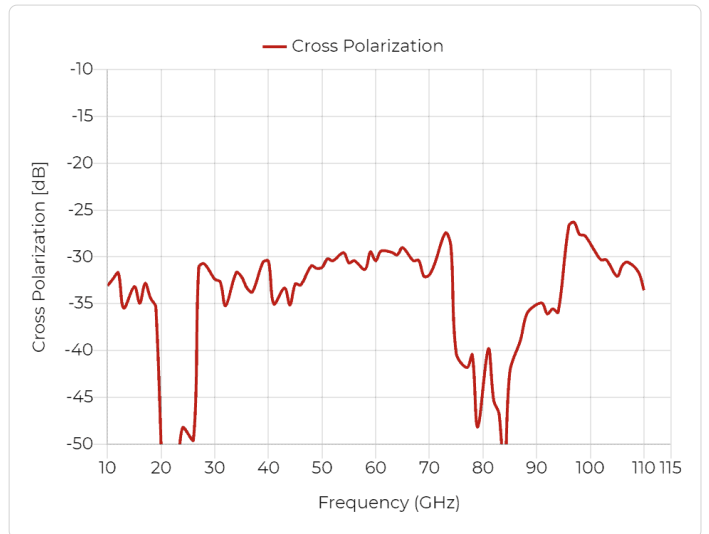

Beamwidth

Port A, E plane

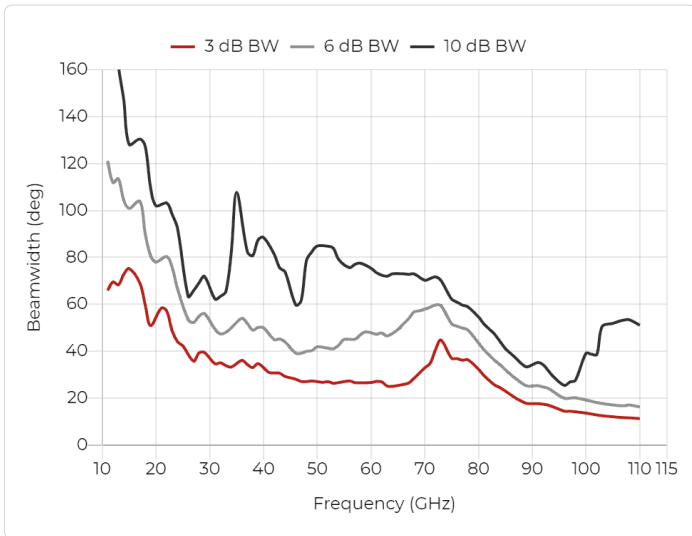

Port A, H plane

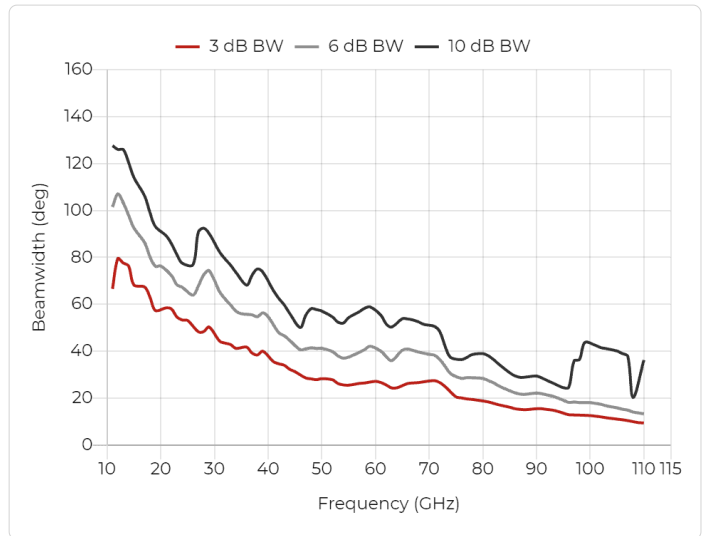

Radiation Patterns

14 GHz

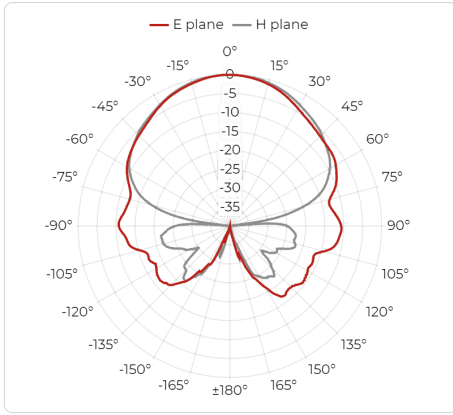

20 GHz

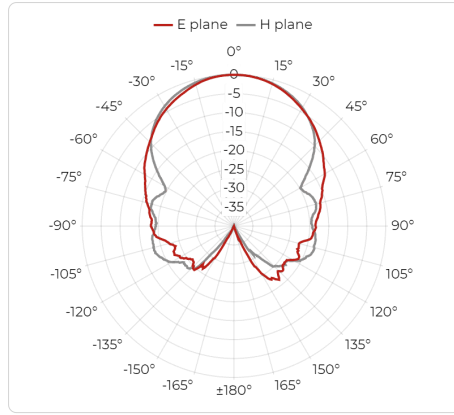

25 GHz

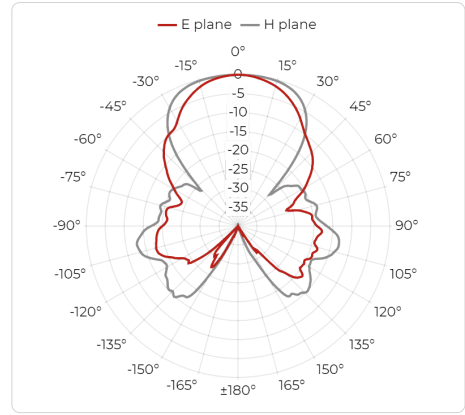

30 GHz

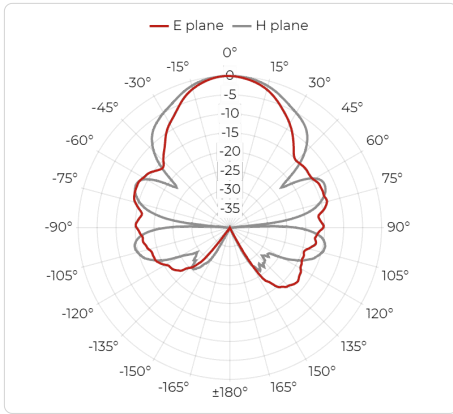

40 GHz

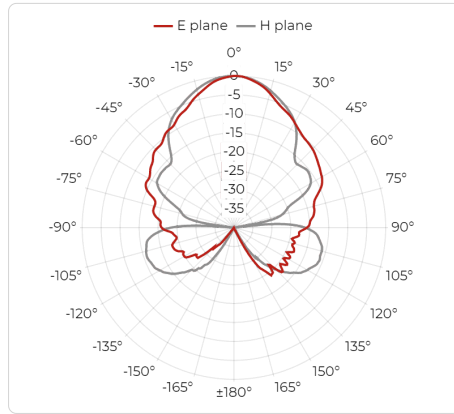

50 GHz

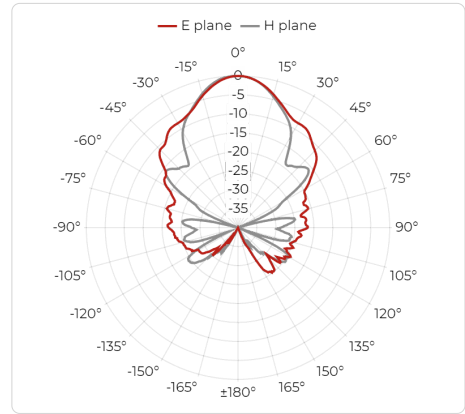

60 GHz

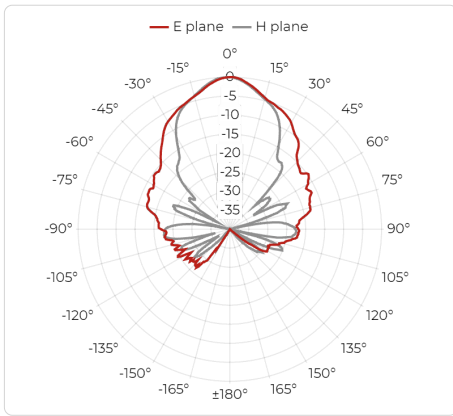

70 GHz

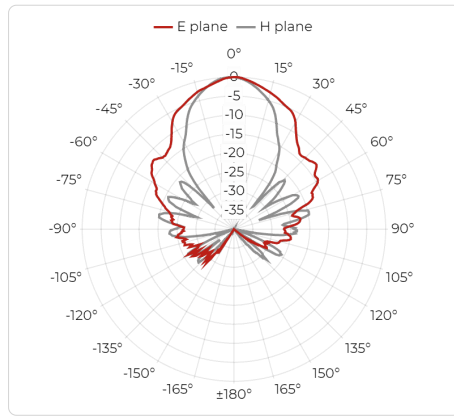

80 GHz

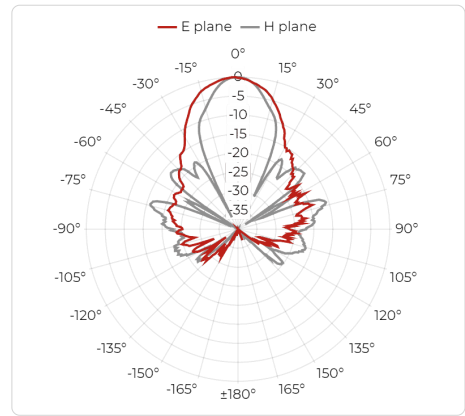

90 GHz

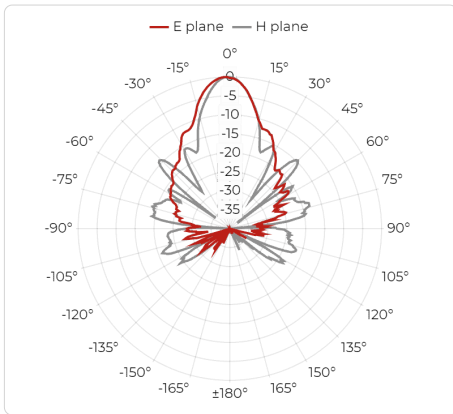

100 GHz

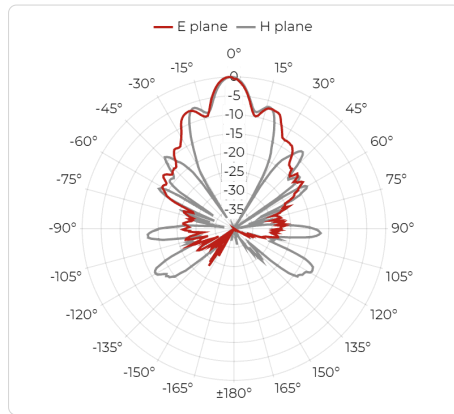

110 GHz

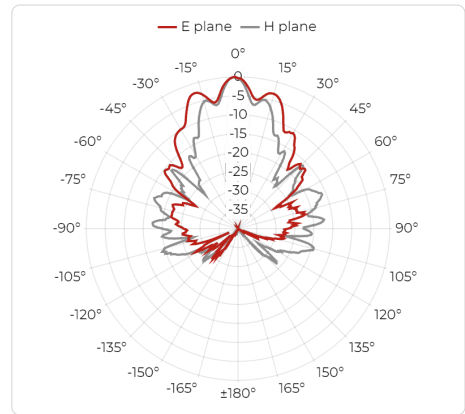

Packaging and Accessories

What's in a box

- DRH110 Antenna
- Antenna specific mount adapter with $\frac{1}{4}$ inch inner thread
- Protective wooden case
- Factory calibration certificate
- Full calibration report of each antenna
- QR code accessing online portal
- Calibration test dataset (available online)

Accessories

- Standard mounting flange



Protective wooden case



Factory calibration report

Optional Accessories

- [AHS2022-14 Antenna Fixture](#)
- [AHS22-HI Antenna Fixture](#)
- [PAS2022 Antenna Stand](#)

Custom services

- Custom mounting solutions
- Custom calibration data

Manufacturer Information

About Datasheet

Product information available also online at
<https://www.rfspin.com/product/drh110/>

Data and specifications subject to change without notice.

Datasheet revision 04-2022.

© RFspin 2022

Address

RFspin s.r.o.
Na Beránce 57/2
160 00 Prague 6
Czech Republic

E-mail

info@rfspin.com

Phone

+420 245 008 847